



CL7206C2 Four- Port Fixed RFID Reader User Manual (V1.0)

Shenzhen Clou IOT Technologies Co., Ltd

打造世界级能源服务商

RFID应用领跑者

Welcome to be user of CLOU RFID products. Thanks for choosing CLOU's Four-Port Fixed RFID Reader CL7206C2. We believe our device will bring convenience for your work.



Catalogue

1. Technical Specification	6
1.1 Product Features	6
1.2 Main function and technical features	6
1.2.1 Main function	6
1.2.2 Technical parameter.....	7
1.2.3 Operational Environment.....	7
2. Sketch map	8
2.1 Physical construction	8
2.2 Weight.....	8
2.3 Illustration of LED display	8
2.4 Sketch map of interfaces	9
2.4.1 Interface description:.....	9
2.4.2 Sketch map of I/O interface	9
2.4.3 Schematic diagram of USB interface	11
2.4.4 Description of feeder line(optional).....	11
2.4.5 Network application connection diagram.....	12
3. Installation instructions	13
3.1 Notes.....	13
3.2 Installation conditions.....	13
3.3 Device connection.....	13
3.3.1 Connect power adapter	13
3.3.2 Connect external antenna and RF cable	13
3.3.3 PC connection	14
3.4 Device installation	14

3.5 Acceptance	14
3.5.1 Acceptance of structure	14
3.5.2 Performance acceptance	14
4. Operating Instruction	15
4.1 Introduction of Demo software	15
4.2 Demo software application environment	15
4.3 Demo software version	15
4.4 Demo software installation	15
4.5 Demo software operation	16
4.5.1 Connect the reader	16
4.5.1.1 Serial communication connection	16
4.5.1.2 Network port communication connection	17
4.5.1.3 RS485 communication connection	18
4.5.1.4 USB communication connection	19
4.5.2 Data display area	19
4.5.2.1 Read EPC	20
4.5.2.2 Read TID	20
4.5.2.3 Custom read	21
4.5.2.4 Stop read	22
4.5.3 Write data	22
4.5.3.1 Write EPC data	22
4.5.3.2 Write user data	23
4.5.3.3 Custom tag action	24
4.5.4 TCP server / client mode	24
4.5.5 Antenna enable configuration	25
4.5.6 Base band parameter configuration	26

4.5.7 Antenna port power setting	27
4.5.8 Clock setting.....	27
4.5.9 Frequency Hopping management.....	28
4.5.10 Label filtering	29
4.5.11 Auto idle configuration	30
4.5.12 GPI/O configuration	30
4.5.13 Advanced configuration.....	32
4.5.14 Tools	33
5. Common failures.....	35
5.1 Daily maintenance	35
5.2 Common failure analysis and solution	35
6. Packing accessories, transportation and storage.....	37
6.1 Package	37
6.2 Accessories.....	37
6.3 Storage environment.....	38
7. After-sale service	39

1. Technical Specification

1.1 Product Features

CL7206C is a high performance four antenna port fixed UHF RFID reader and writer; support ISO18000-6C/6B protocols. The work frequency includes China standard dual frequency 920MHz ~ 925MHz and 840MHz~845MHz, FCC 902MHz ~ 928MHz and ETSI 865MHz ~ 868MHz.

Output power from 0 ~ 33dBm optional, with long identification distance, fast reading speed, high accurate rate, strong anti-interference ability, good protection performance and easy installation

1.2 Main function and technical features

1.2.1 Main function

- Protocol: support ISO18000-6C/6B standard
- Built-in LINUX operating system
- Multiple communication port (Ethernet, RS232, RS485, USB)
- Support tag data filtering
- Support RSSI: the intensity of the perceived signal
- Adjustable RF output power
- Optional working mode: constant frequency / frequency hopping
- Supports antenna detection function
- Supports online and remote upgrade
- I/O interface: 4 port opt coupler input, 4 port relay output and Weigand output

1.2.2 Technical parameter

- Working frequency: GB 920MHz~925MHz, GB 840MHz~845MHz,
FCC 902MHz~928MHz, ETSI 865MHz~868MHz
- Output power (port): 33dBm + 1dB (MAX)
- Power adjustment: 1 dB step-by-step
- Reading distance: 0 ~8meters (depending on tags, antennas and environment)
- Channel bandwidth: <200 KHz
- RS232 serial communication rate: 115200bps (default), 19200 bps, 9600bps
- RS485 interface communication rate: 115200bps (default), 19200 bps, 9600bps
- Support: Weigand 26, 34, 66 interfaces
- Power supply: 30V ~ 10V (power capacity is not less than 60W)
- Power adapter: AC input 100V ~ 50Hz, 240V ~ 60Hz
- DC output: 24V/2.5A
- High protection grade: IP54

1.2.3 Operational Environment

- Working environment: -20°C ~ +70°C
- Relative Humidity: 5%RH~90%RH (+25°C)

2. Sketch map

2.1 Physical construction

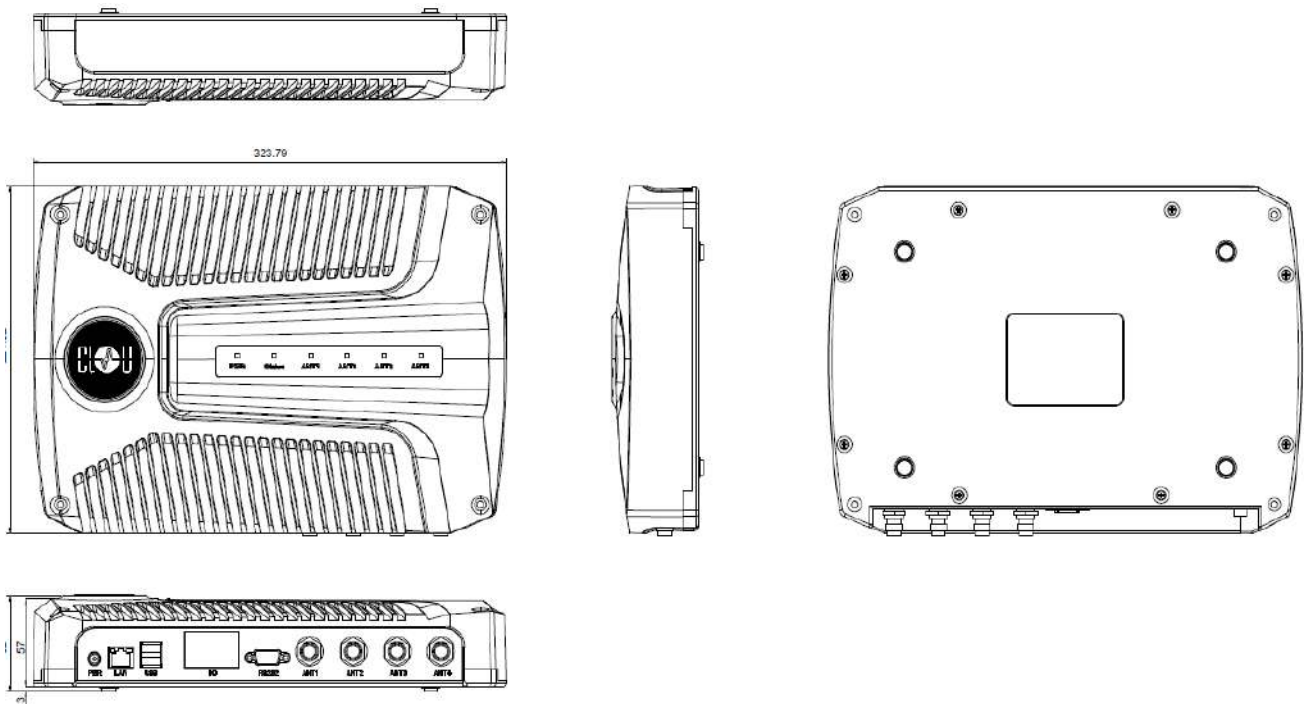

Image 2-1 Structure diagram of CL7206C2

Volume of four-port fixed rfid reader CL7206C2:

324mm*225mm*62mm (accessories excluded)

2.2 Weight

About 2.6kg (accessories excluded)

2.3 Illustration of LED display



Image2-2 Sketch map of reader's LED indicator

LED indicator panel describe as below Form 2-1:

Form 2-1 LED indicator description

LED Mark NO.	Mark NO.	Status description
ANT1	Antenna 1 indicator	Indicates antenna 1 is working
ANT2	Antenna 2 indicator	Indicates antenna 2 is working
ANT3	Antenna 3 indicator	Indicates antenna 3 is working
ANT4	Antenna 4 indicator	Indicates antenna 4 is working
Status	Status indicator	Flashing indicates recognition to tags
POWER	Power indicator	Keep bright indicates power supply working normally

2.4 Sketch map of interfaces

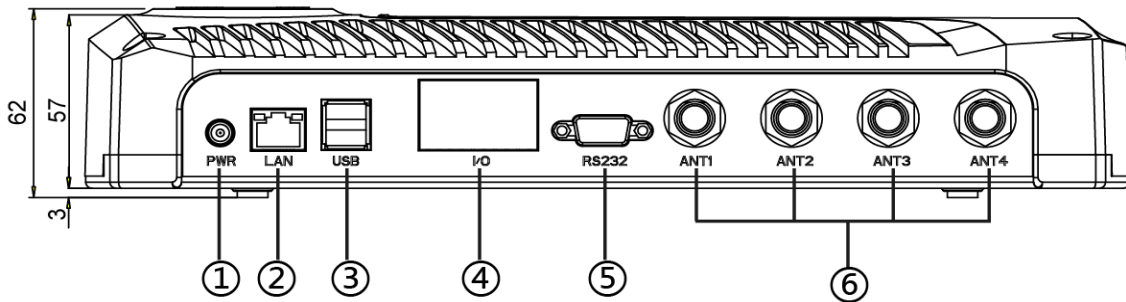

Image 2-3 Sketch map of reader's I/O and communication interface

2.4.1 Interface description:

- 1 - power interface
- 2 - network communication interface
- 3 - USB interface
- 4 - I/O interface
- 5 - RS232 communication interface
- 6 - Antenna interface (4 TNC connectors)

2.4.2 Sketch map of I/O interface

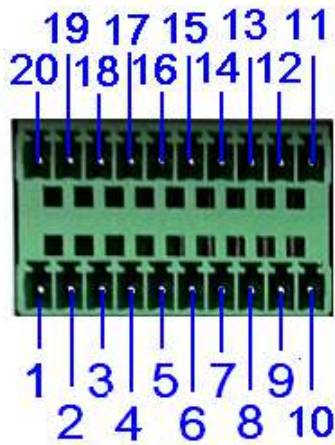

Image 2-4 Sketch map of I/O control interface

I/O control signal define as follow form 2-3

Form 2-3 I/O control signal definitions

Aviation pin	description of pin	pin definitions
1	Relay 1 output port	OUT_R1
2	Relay 2 output port	OUT_R2
3	Relay 3 output port	OUT_R3
4	Relay 4 output port	OUT_R4
5	optocoupler 1 external signal input positive	IO_INPUT1
6	optocoupler 3 external signal input positive	IO_INPUT3
7	optocoupler external signal input negative	IO_GND
8	Weigand output signal 0	Wiegand_DATA0
9	Weigand output signal 1	Wiegand_DATA1
10	ground	GND
11	ground	GND
12	RS485-B signal	RS485-B
13	RS485-A signal	RS485-A
14	ground	GND

15	optocoupler 4 external signal input positive	IO_INPUT4
16	optocoupler 2 external signal input positive	IO_INPUT2
17	Relay 4 output port	OUT_L4
18	Relay 3 output port	OUT_L3
19	Relay 2 output port	OUT_L2
20	Relay 1 output port	OUT_L1

2.4.3 Schematic diagram of USB interface

USB interface application:

1: Application software online upgrade (as shown in figure 2-5 "USB interface")

2: USB communications, serial port and network communication all in one (as shown in figure 2-5 USB communication interface")



Image 2-5 schematic diagram of usb communication port

2.4.4 Description of feeder line(optional)



Image 2-6 schematic diagram of feeder line

RF cable TNC connector connect with reader antenna TNC connector, RF cable SMA connector connect with external circular polarization antennas SMA connector, cable maximum length is 5m, impedance 50Ω,

insertion loss is less than 2dB, or you also can choose a high performance cable, appropriate increase in length, insertion loss is less than 2dB.

Note: If Ultra long RF cable or the cable joint is not contacted well, may cause performance deterioration on the read and write because of the emission signal and the received echo signal's attenuation.

2.4.5 Network application connection diagram

Network interface used for long-distance high-speed connection (less than 80 m), can be connected with the switcher or router through the network cable, or directly connected with the PC network interface, as shown in figure 2-7:

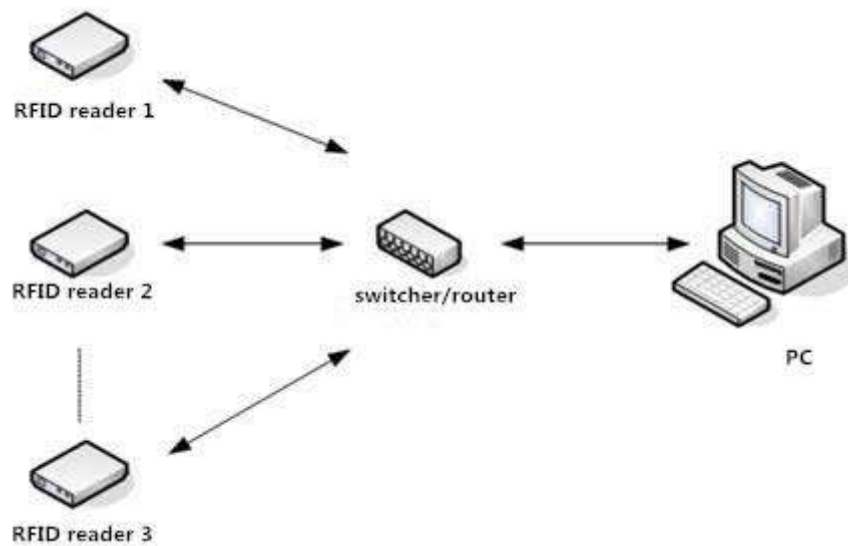

Image 2-7 Network application connection diagram

3. Installation instructions

3.1 Notes

To ensure the normal and stable operation of the device and your personal property and safety, please carefully read the following notes before install CL7206C reader and writer:

1. Firstly, check whether the power socket is connected to the ground, and to see whether the local power supply voltage is in accordance with the applicable voltage range of the reader;
2. Check the device and the external connection if is closely connected;
3. Pay attention to the type selection and the length limit of the cable and the serial line:
 - Cable connect directly, no longer than 80 meters
 - Serial line connect directly, no longer than 10 meters
4. When installing several readers, the antenna position and the antenna spacing should be appropriate to avoid interference with each other.

3.2 Installation conditions

Before installing the reader, please carefully check if the product is in good condition, the accessories are complete or not, if there is any damage, please contact the supplier.

3.3 Device connection

3.3.1 Connect power adapter

Insert the power cord into the AC power supply socket and plug another end into the power connector of the device and tighten.

Turn on and wait about 20 seconds, the system initialization process is completed and is standby state.

3.3.2 Connect external antenna and RF cable

The device built with four TNC coaxial cable connector for connecting an external antenna, select low consumption RF cable, connectors should be tightened (Ensure to be waterproof when install outdoors);

The reader antenna angle or corner to adjust to the best position through the actual test according to the specific application,.

3.3.3 PC connection

The device provides special adapter cable, including interface of network, serial and power;

RS232 interface is for short distance communication (less than 10m), through the DB9 connector and the PC serial port connection to realize the communication of PC and the device.

RJ45 network port used for long distance communication (less than 80m), connect PC with extend cable.

3.4 Device installation

The reading and writing range of the reader depends on the onsite application, the tilt angle of the antenna is adjusted to achieve the best reading and writing performance.

3.5 Acceptance

Mainly from two aspects of acceptance criteria: structure and performance.

3.5.1 Acceptance of structure

- If reader is fixed firmly, without loose;
- If the cable connected firmly ;
- If the screws are tighten

3.5.2 Performance acceptance

- If the reader is working properly;
- If the read and write range is reasonable.

4. Operating Instruction

4.1 Introduction of Demo software

The demo software mainly carries on system control, communication mode selection, parameter setting and searching, read and write tags and data presentation and so on.

Before using the demon software, please check if the connection of the reader hardware is completed, mainly ensure the following tips:

- 1, If the reader and computer serial port (network or RS485) is connected correctly
- 2, If the antenna ports have been connected to the antenna (ANT, ANT1 2, ANT 3, ANT totally four ports)
- 3, If the reader and writer start up (hear "drop" buzzer sound).

4.2 Demo software application environment

◆ The software environment

Windows 2000 Service Pack 3、 Windows Server 2003、 Windows XP Service Pack 2、 Windows 7 system

◆ The hardware environment

P4/1.7GHz above PC, 512M or more memory, 40GB hard drive

4.3 Demo software version

◆ V1.0.1

4.4 Demo software installation

1. Copy the software to the PC, open the software installation package, double click “ setup” application, follow the installation guide.
2. Click the next step, and select the installation path, click next, and the software will begin to install.
3. Click the "Install", and software installation progress takes about 1mins.
4. After the progress of the software is finished, click the "finish" button to complete the installation.

4.5 Demo software operation

4.5.1 Connect the reader

All functions can be operated only after successful connection.

4.5.1.1 Serial communication connection



Double click the icon to start the Demo software, the main interface of the toolbar icons are gray means reader is not connected, in the 'connecting reader' option list select communication mode 'serial connection', 'connection parameters' select 'COM?' (choose PC serial number), communication rate select 115200 (default), click OK button, as shown in image 4-6.

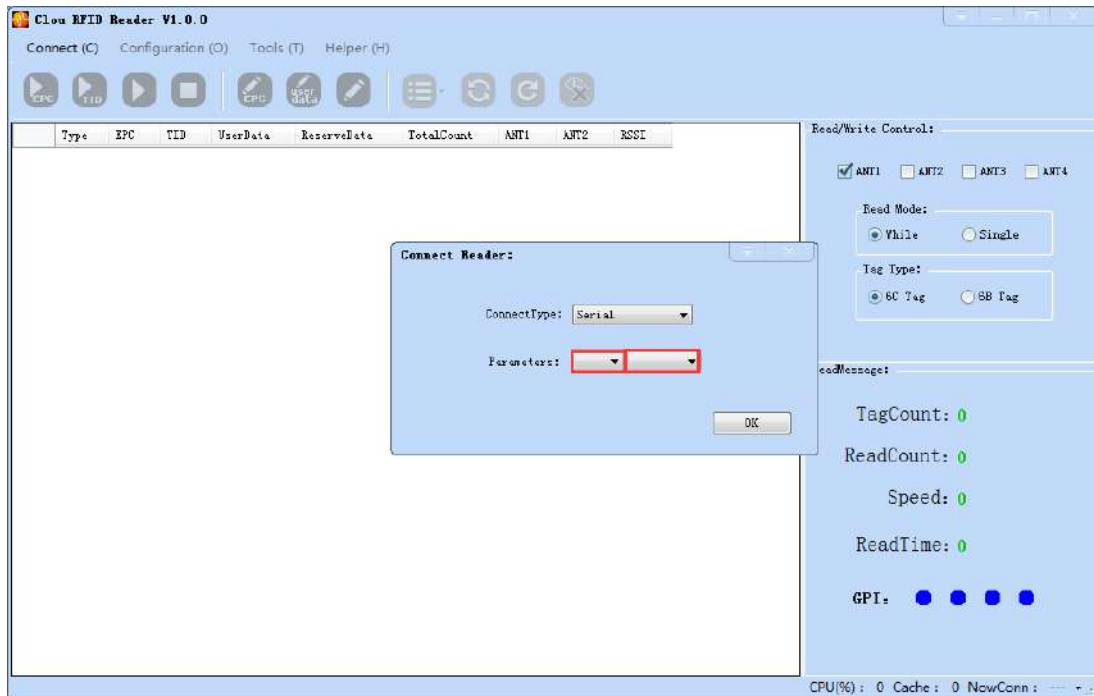
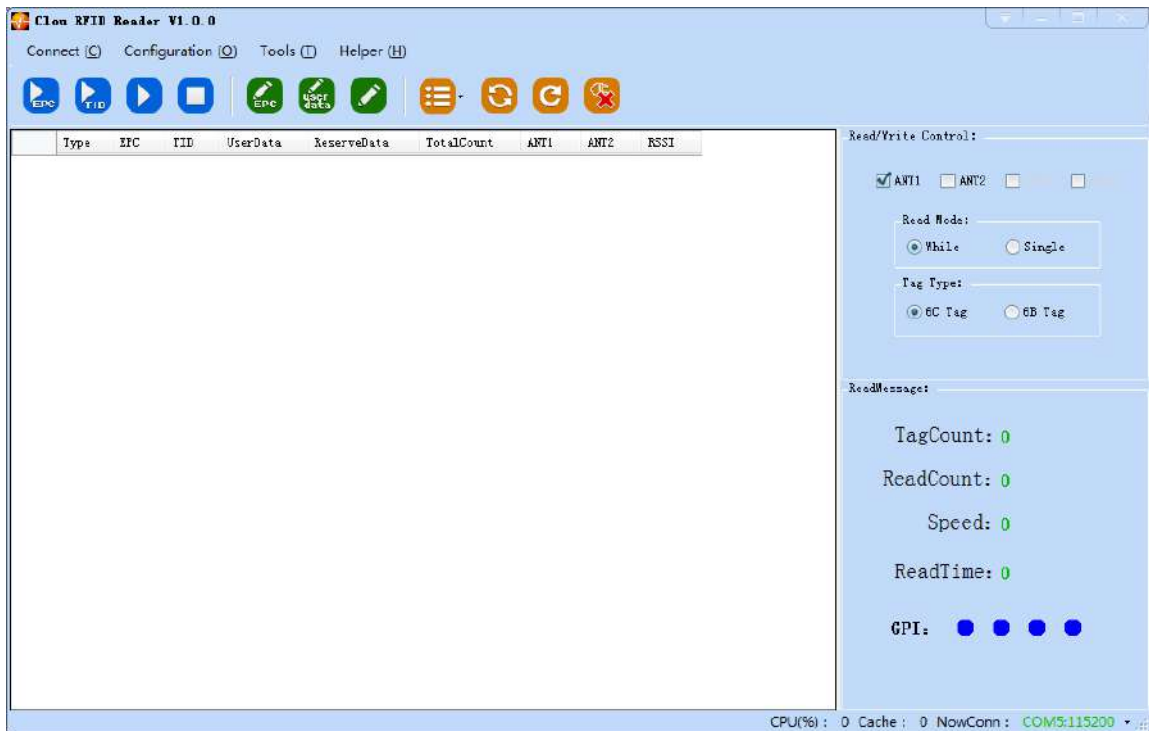

Image 4-6 Serial communication connection

If the connection is successful, all the icons in the toolbar are illuminated, as shown in image 4-7, means the serial communication connection is successful.



Imag4-7 serial port communication connect successful

4.5.1.2 Network port communication connection

Network port used for long distance connection (within 80 m), connect to the router through cable and switcher, or connected with the PC network port directly. Select the communication mode "TCP connection" in the "connect reader" option list, "connect parameter" input reader IP (default 192.168.1.116), enter the communication port number (default 9090), and click OK button, as shown in image 4-8

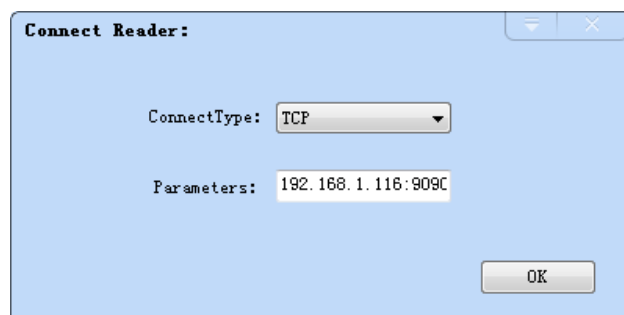

Image 4-8 Network port communication connection

The device has been written IP address 192.168.1.116 as default. If you forget or need to modify, using serial connection "connection" after connect successfully, then you can found the current IP address through

select "settings" > "senior" > "configuration", set up the IP address in "Network port settings" when "configuration" dialog pops up.

Note: The IP address of the reader can't be repeated. Use the Ping command to test whether the network is connected on PC.



Image 4-4 Settings of reader

4.5.1.3 RS485 communication connection

Select the communication mode in the "connect to the reader" option "485 connection (serial port)", "connect parameter" select "COM?" (select PC serial number), communication rate select "115200", enter the RS485 address, then click OK, as shown in image 4-10.

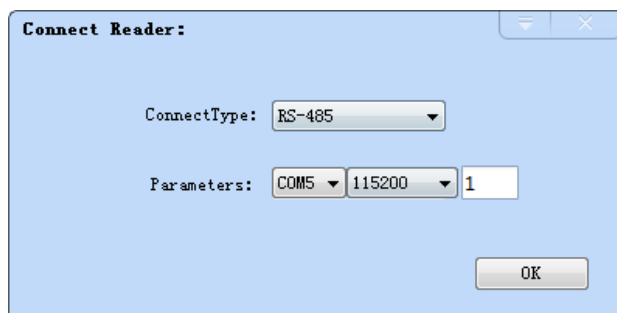



Image 4-10 485 communication connection

RS485 address defaults to 1

RS485 address range 1~255

Note: Click the button  after changing the configuration

4.5.1.4 USB communication connection

Select the communication mode "serial port" in the "connect reader" option list, "connect parameter" select "COM?" (the USB serial number detected by PC), the communication rate is selected "115200" (the default value), and click OK button, as shown in image 4-11.

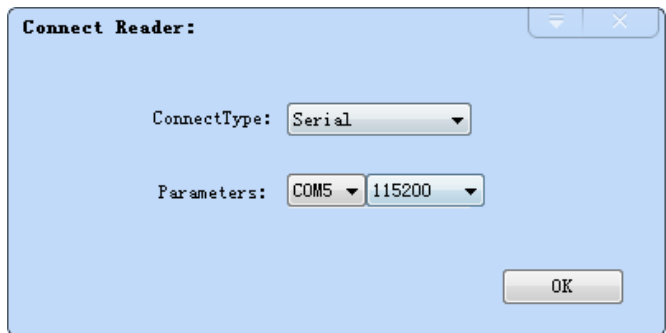

Image 4-11 USB communication connection

4.5.2 Data display area

Click the button , the data display area will show as image 4-12

Type	EPC	TID	UserData	ReserveData	TotalCount
6C	300833B2DD901400000000	E2801105200046DD660B002F			6
6C	1234	E280110520004513660F002F			6
6C	300833B2DD9014000000000	E2801105200045456612002F			5
6C	300833B2DD9014000000000	E280110520004512660F002F			5
6C	300833B2DD9014000000000	E2801105200046436612002F			6
6C	300833B2DD9014000000000	E2801105200046CA660C002F			5
6C	300833B2DD9014000000000	E2801105200046596611002F			6
6C	300833B2DD9014000000000	E28011052000454E6612002F			6
6C	300833B2DD9014000000000	E28011052000451E660D002F			6
6C	300833B2DD9014000000000	E28011052000464C660C002F			6
6C	300833B2DD9014000000000	E28011052000454D660E002F			6
6C	300833B2DD9014000000000	E28011052000451C660D002F			6
6C	300833B2DD9014000000000	E280110520004651660F002F			6
6C	300833B2DD9014000000000	E28011052000475D660D002F			6
6C	300833B2DD9014000000000	E28011052000484C661D002F			6
6C	300833B2DD9014000000000	E2801105200047096612002F			6
6C	300833B2DD9014000000000	E2801105200045516617002F			5
6C	300833B2DD9014000000000	E280110520004541660C002F			6
6C	300833B2DD9014000000000	E28011052000464D660C002F			6
6C	300833B2DD9014000000000	E28011052000474C6614002F			5
6C	300833B2DD9014000000000	E2801105200047926611002F			2

Image 4-12 data display area parameter meanings

Type: label type: 6C, 6B two types

EPC: EPC data of tags, can be read and write.

TID: the TID data of the label, the only logo, read only

User Data: user data area, can be read and write.

Reserve Data: reserved area data, store the password data, etc.

Total Count: total number of tags

ANT1: the reading times of NO.1 antenna

ANT2: the reading times of NO.2 antenna

ANT3: the reading times of NO.3 antenna

ANT4: the reading times of NO.4 antenna

RSSI: Signal Intensity

4.5.2.1 Read EPC

Click the button , the data display area will display the current read EPC data

EPC display as hexadecimal character string, use the word as length unit (1 word = 2 bytes = 4 hexadecimal character)

If you want to read the EPC data of the custom length, please refer to chapter 4.5.2.3 custom read

4.5.2.2 Read TID

Click the button , the data display area will display the current read EPC and TID data

TID data display as hexadecimal character string, use the word as length unit (1 word = 2 bytes = 4 hexadecimal character).

TID length, the default is 6 words.

If you want to read the TID data of the custom length, please refer to chapter 4.5.2.3 custom read

4.5.2.3 Custom read

Click the button , pop-up dialog box, as shown in Image 4-13

Select "6C tag configuration"

Matching read, you can matching read through known EPC data or TID data of tags.

Read TID, select to read the tag TID data, the read mode default as "adaptation", use the word as length unit.

Read the user area, select to read the tag user area data, use the word as the starting address and read length unit

Read the reserved area, select to read the tag retains data, use the word as the starting address and read length unit

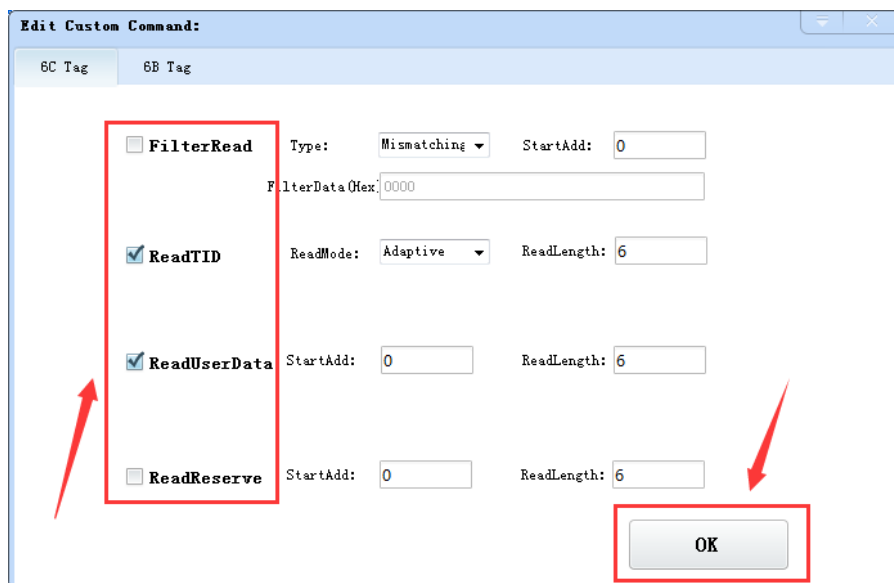

Image 4-13 6C Tag custom configurations

Select the 6B tag configuration, and pop up dialog box as shown in image 4-14

Can choose to read TID data or user data

Can matching read TID data.

Tip: Customer who not familiar with the label agreement, please ignore this feature

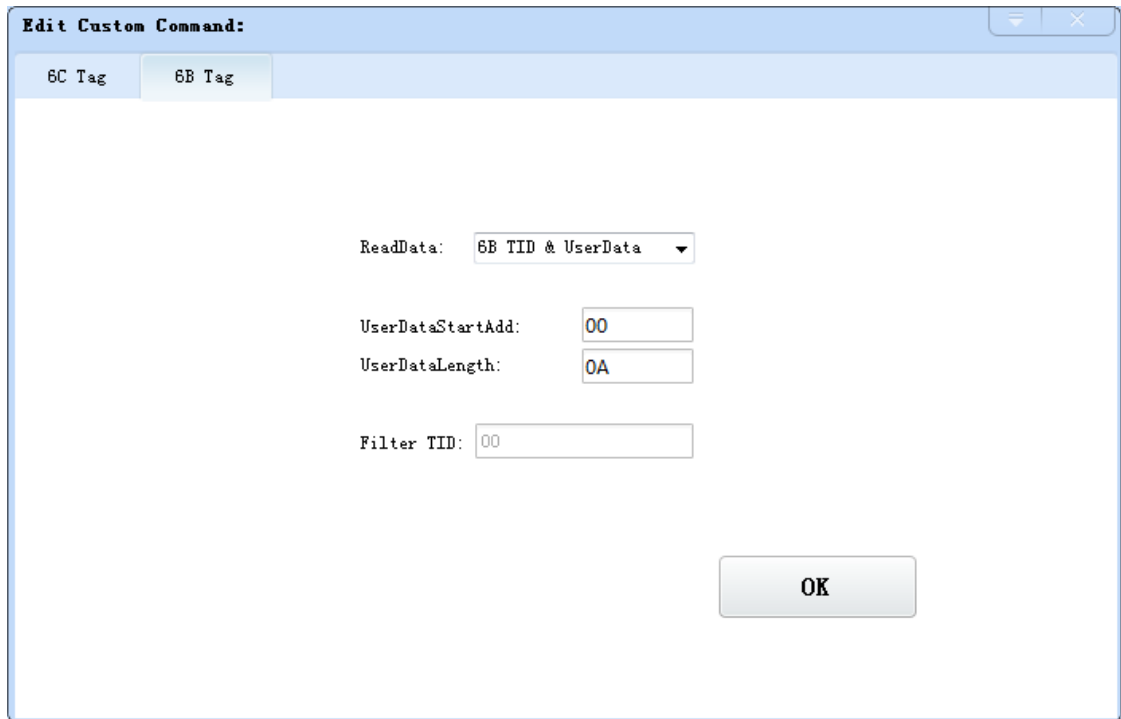



Image 4-13 6B Tag custom configurations

4.5.2.4 Stop read

Click button  stop all read and write operations.

4.5.3 Write data

4.5.3.1 Write EPC data

Click button  and pop up dialog box as shown in image 4-15:

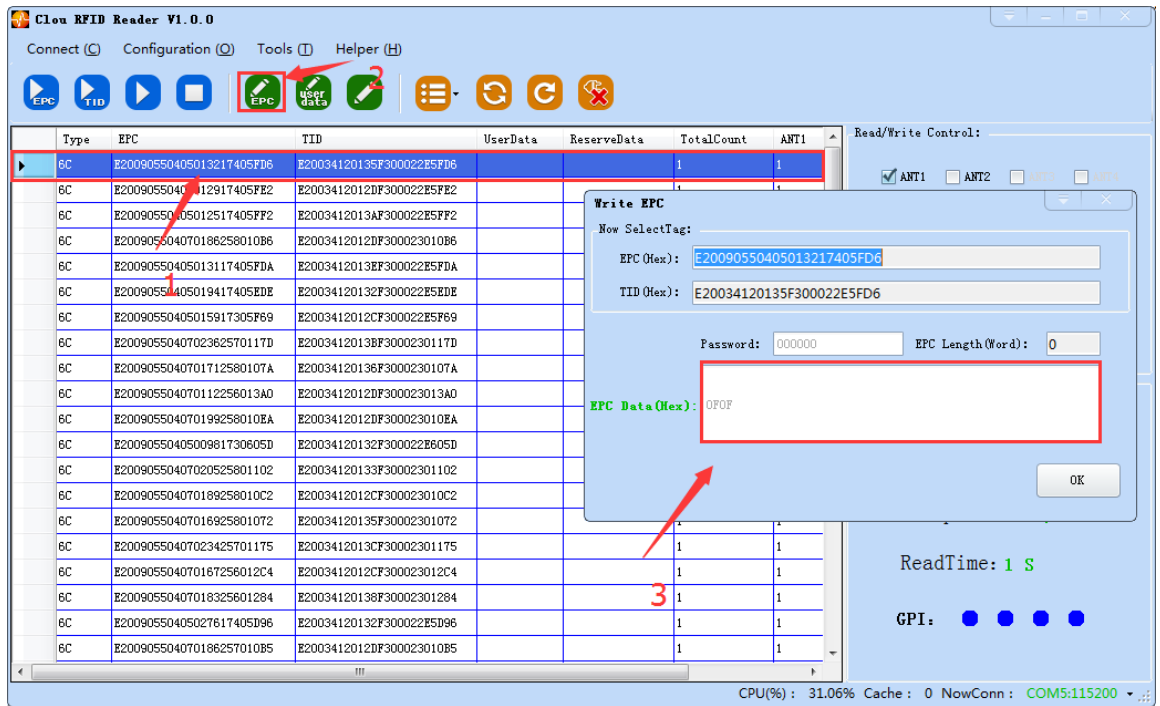



Image 4-15 write EPC data

Select a label data (contains TID information) has been read, fill in the EPC data (16 hex string), click "OK".

4.5.3.2 Write user data

Click button  and pop up dialog box as shown in image 4-16:

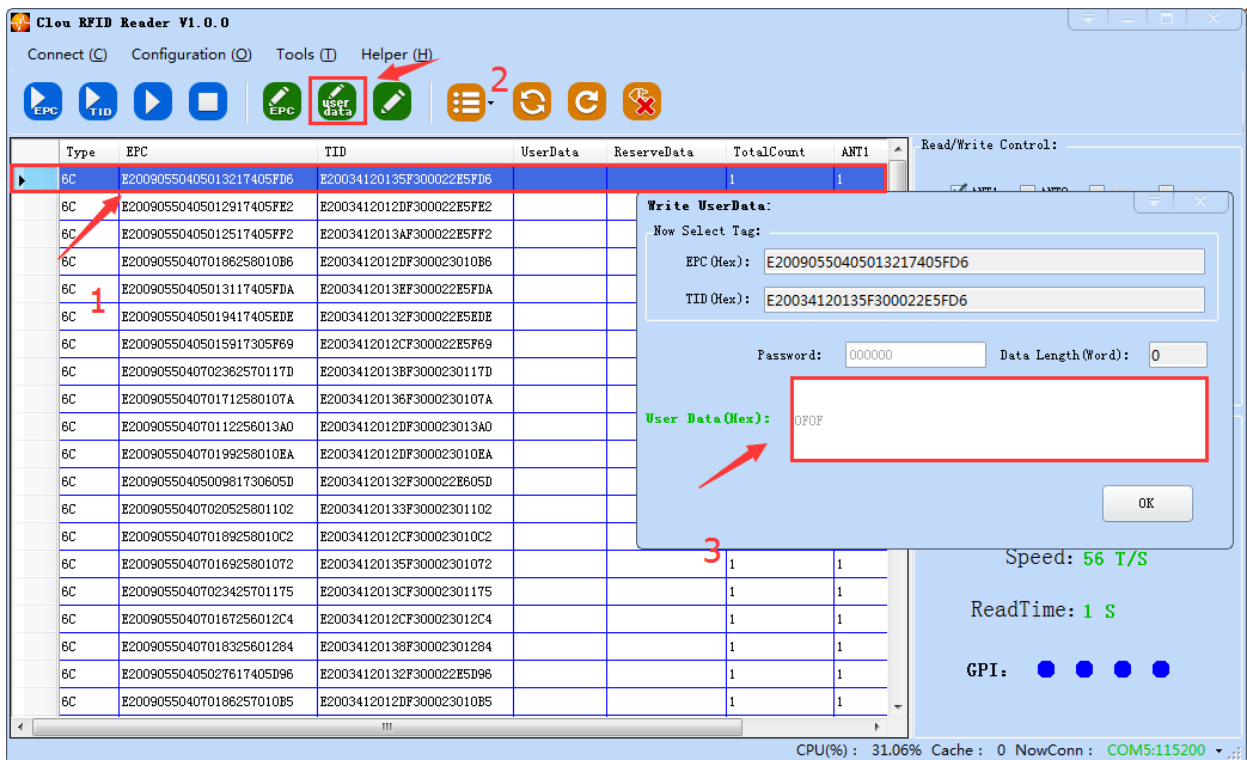

Image 4-16 write user data

Select a label data (contains TID information)has been read, fill in the user data (16 hex string), click "OK".

4.5.3.3 Custom tag action



Click button and pop up dialog box as shown in image 4-17:

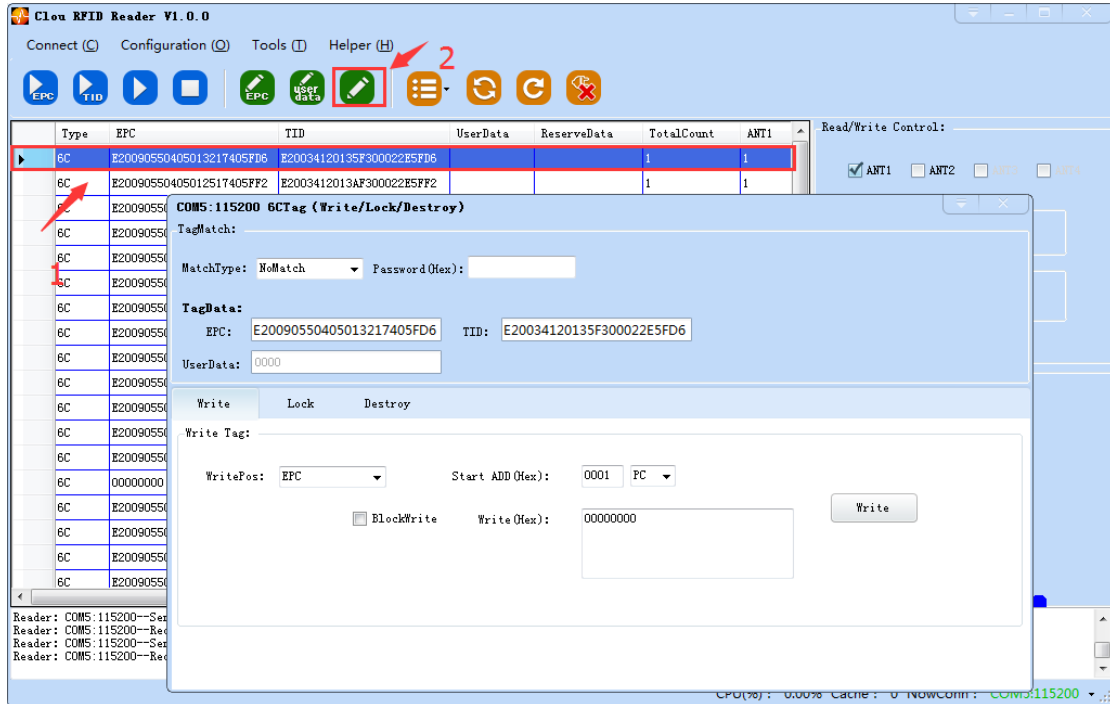

Image 4-17 Custom tag action

1. Select a tag data that has been read;
2. Click the "custom operation" button;
3. Take detailed action to write / lock / destroy tag according to the reader protocol

4.5.4 TCP server / client mode

Select configuration on the main demo interface > "read and write configuration >" TCP server / client mode ", pop-up dialog box, as shown in Image 4-18:

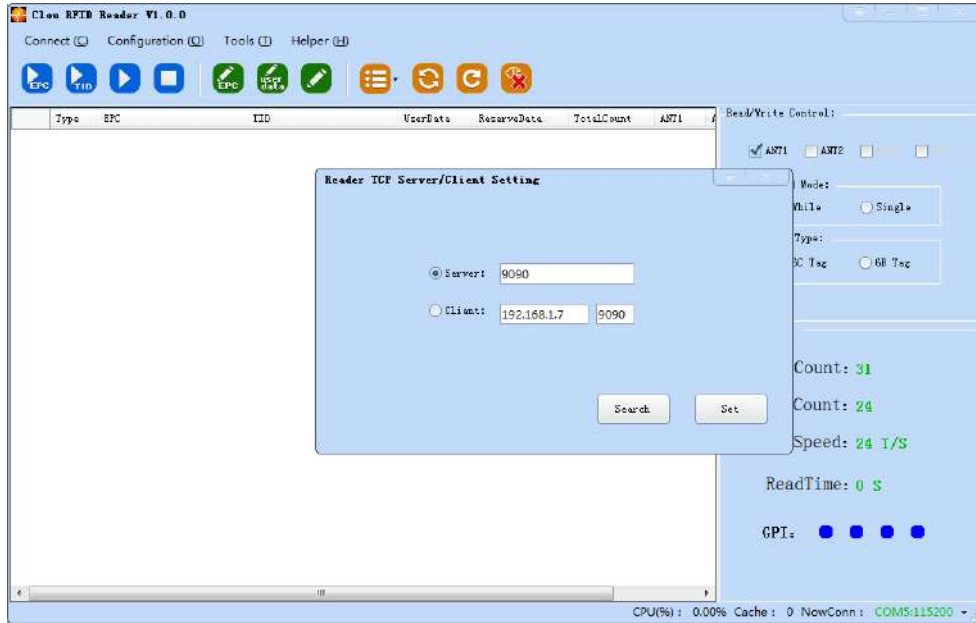

Image 4-18 Mode setting

When the reader is configured as a "server" mode, the connection is initiated by PC; when the reader set as a "client" mode, it will connect to the PC side automatically.

4.5.5 Antenna enable configuration

Select "configuration" on the DEMO main interface-- > "senior"-- > "reader configuration ", then pop-up dialog box, as shown in image 4-19.



Image 4-19 Antenna enable configuration

Select all antenna enable configuration, click the "configuration", pop up dialog box, click "OK" means

configure succeeds. If the antenna enable is not selected, when select the corresponding reader on the DEMO main interface, will pop up dialogue box as shown in image 4-20.

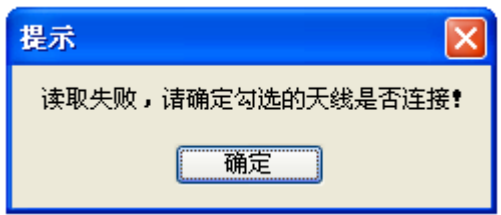

Image 4-20 Antenna selection

4.5.6 Base band parameter configuration

Select "configuration" on the DEMO main interface --> "senior" --> "reader", then pop-up dialog box, as shown in image 4-21.



Image 4-21 Base band parameter configuration

Changing the base band parameter configuration can change the actual effect of the read and write (can be reasonably configured according to the application scenarios, but it needs to be operated under the guidance of our engineers).

EPC base band rate provides five options: Tair=25us, FM0, LHF=40KHz, dense reading mode;

Tair=25us, Miller4, LHF=300KHz; fast reading mode; 255/OUTO.

Session four choices: 0; 1; 2; 3.

Q values provide sixteen options: 0/ single label; 1; 2; 3; 4/ multi label; 5; 6; 7; 8; 9; 10; 14; 11; 12; 13; 15.

There are three options for searching tags: one sided search; inventory only with Flag B; double search.

4.5.7 Antenna port power setting

Select "configuration" on the DEMO main interface --> "senior" --> "reader", pop-up dialog box, as shown in image 4-22.



Image 4-22 Antenna port power setting

Select the corresponding antenna port (external antenna connected), select the appropriate power values from the power list, click Configure, pop up the configuration of the success of the dialog box, click OK to complete power configuration.

4.5.8 Clock setting

Select "configuration" on the DEMO main interface --> "senior" --> "reader configuration", then pop-up dialog box, as shown in image 4-23. The current time of the reader can be check in the area of the "reader time". If you need to modify the reader time, modify the "reader time" then click "configuration" button, pop-up dialog box then click OK.



Image 4-23 Clock display setting

4.5.9 Frequency Hopping management

Click "configuration" on the main interface > RFID configuration > "hopping management", pop-up frequency hopping management dialog box, as shown in image 4-24

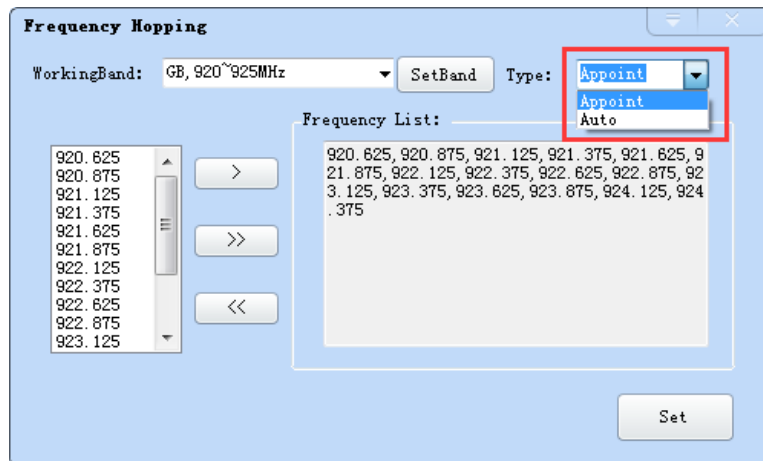

Imag 4-24 Frequency Hopping management

Select "CMII, 920-925MHz" (see Image 4-25) in the "working band" drop-down list, click the "Settings", select single frequency points from the left frequency list box(see Image 4-24) then click the ">" button, right into the list box, and then click the "configuration" to confirm; If you want to select the full band frequency hopping just click >> all the frequency points will show on the right side of the list box, click the "configuration" to confirm. If you click <<, all frequency points on the right side of the list box will be cleared.

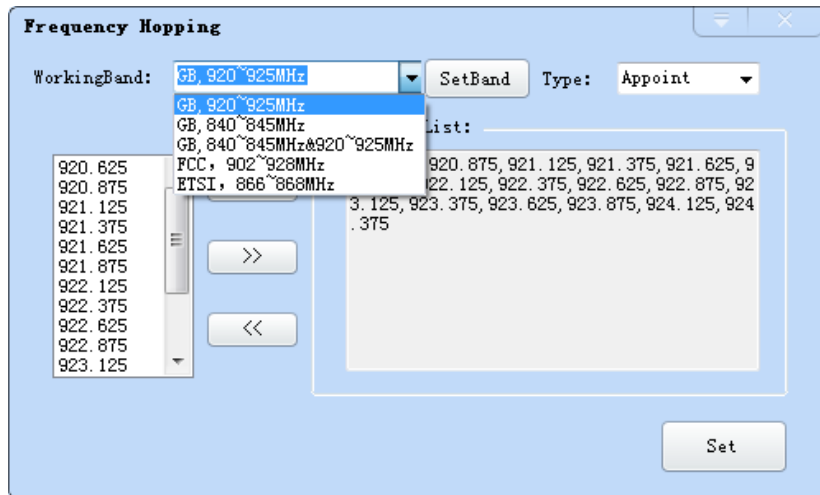

Image 4-25 Frequency Band selection

Note: The purpose of setting up the "automatic" is to avoid the interference of the external signal and select the fast frequency hopping. The default configuration for general application is automatically (as shown red mark dropdown list in image 4-24).

4.5.10 Label filtering

Select "configuration" on the main interface > "RFID configuration" > "label filter", then pop-up dialog box, as shown in image 4-26:

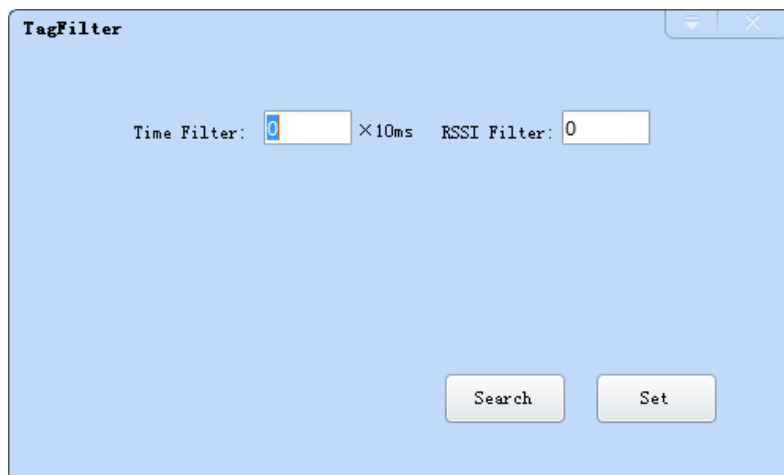

Image 4-26 label filtering

Filtering time: indicates that the same label content within a specified period of time within a read card instruction is only uploaded once, 0~65535, and time units: 10ms.

RSSI threshold: When label RSSI value small than the threshold value, the label data will not be uploaded

and discarded.

4.5.11 Auto idle configuration

Select "configuration" on the main interface > "RFID configuration" > "auto idle ", then pop-up dialog box, as shown in image 4-27:

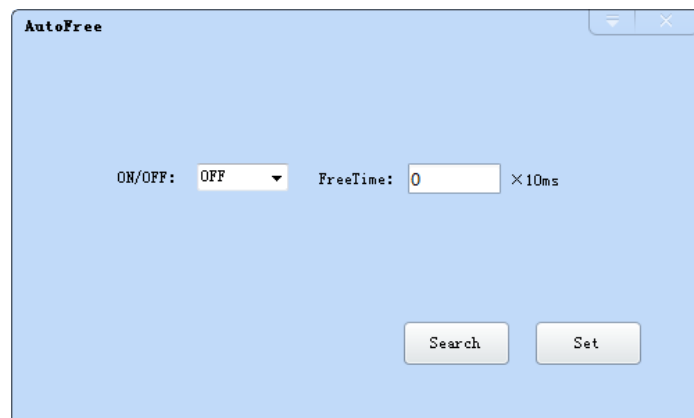

Image 4-27 Auto idle configuration

Auto idle mode means when the reader continuous reading tags, all using antenna didn't identify the tags for three times continuously ,then the reader automatically enter a period of idle state to save power consumption, the reader re-enter the card reader automatically after idle time.

4.5.12 GPI/O configuration

GPI/O control to provide the query and set up the I/O port state, control the function of the I/O device.

GPI configuration

Select "configuration "on the main interface > "GPI/O configuration" > "GPI configuration "then pop-up dialog box, as shown in image 4-28:

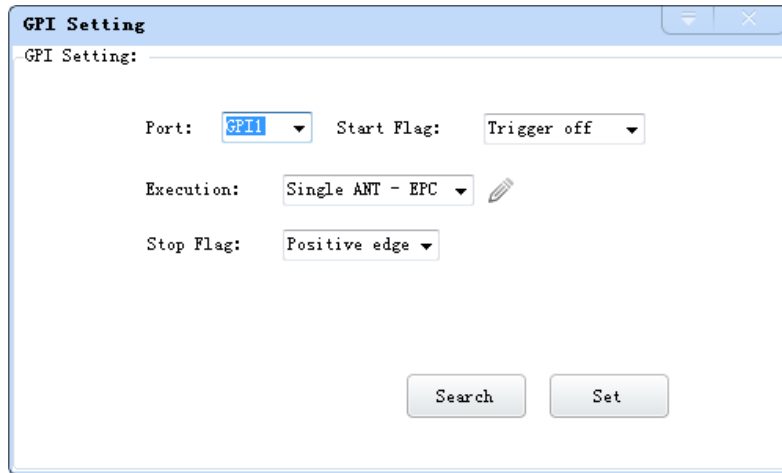

Imag 4-28 GPI configuration

- Check: check the various port trigger parameters
- Configuration: select the port need to set, click button to execute the settings after modify
- Trigger start condition: select the mode from the drop-down list
- Trigger execution instruction: select the mode from the drop-down list
- Trigger stop condition: select the mode from the drop-down list
- Description: when the start condition is satisfied, the reader will perform the configuration of the reader/writer command.

GPO configuration

Select "configuration" on the main interface > "GPI/O configuration" > " GPO configuration "then pop-up dialog box, as shown in image 4-29:

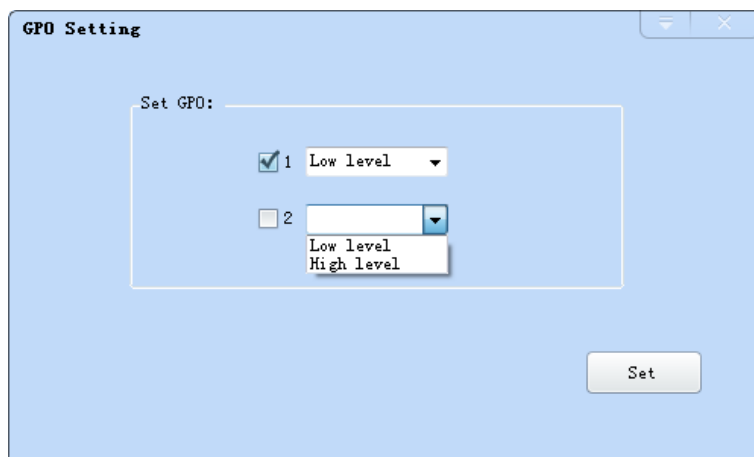

Image 4-29 GPO configuration

CL7206C reader only supports two GPO outputs, that is "1" and "2".

Select the high / low level, click this configuration to execute settings after modify.

4.5.13 Advanced configuration

Weigand configuration

Select "configuration" on the main interface > "GPI/O configuration" > "Weigand "then pop-up dialog box, as shown in image 4-30:

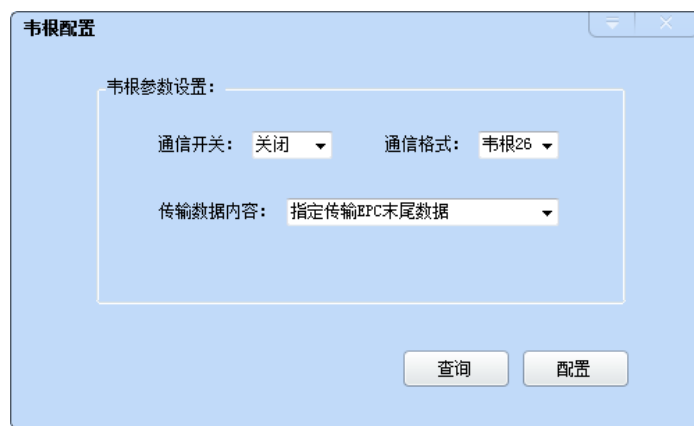

Image 4-30 Weigand configuration

In the Weigand parameter settings area, set up the "communication switch" for the "open" state, and select the corresponding "communication format" and "transmission data content", click on the "configuration" to determine.

Weigand port Parameter configuration: includes "Weigand 26, "Weigand 34" and "Weigand 66" models.

Weigand 26: TID or EPC data reported from the end of the Weigand port is valid for 3 bytes.

Weigand 34: TID or EPC data reported from the end of the Weigand port is valid for 4 bytes.

Weigand 66: TID data reported from the end of the Weigand port is valid for 8 bytes.

Restore factory settings

Select "configuration" on the main interface > "restore factory settings" then pop-up dialog box, as shown in image 4-31:



Image 4-31 restore factory settings

When connected to the reader in any form, click OK button, and all settings of the reader will be restored to the factory setting.

4.5.14 Tools

Data export

Select "tools" on the main interface > "data export" > "form (*.XLS)", in the pop-up dialog box, as shown in image 4-32, select the required export file save path.

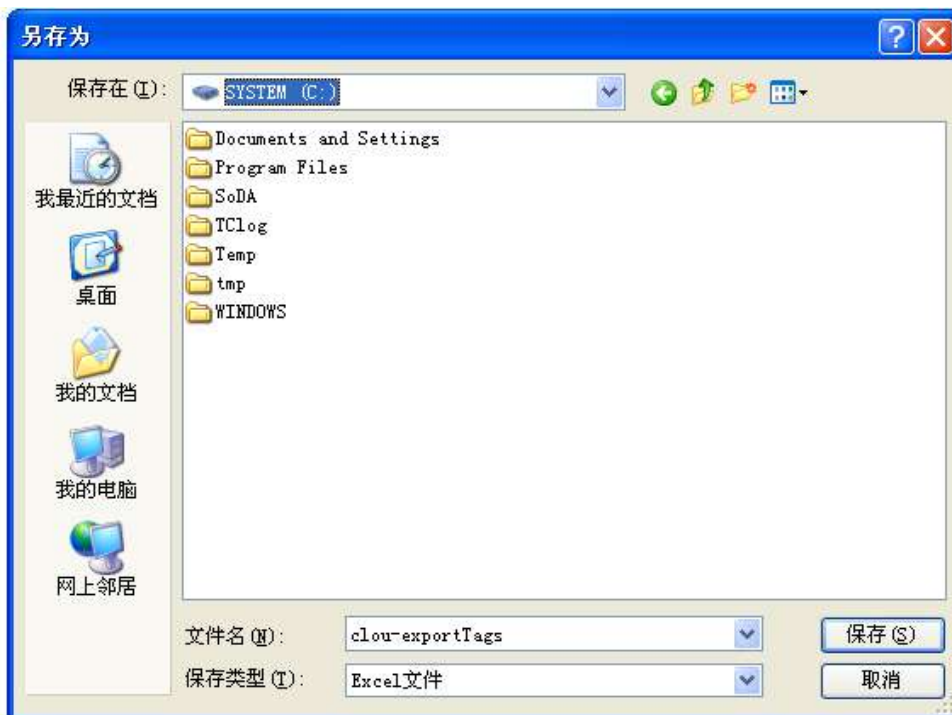

Image 4-32 Data export

Read the tag data to support data export, export format can be.Csv (comma file) and.Xls (Excel).

Software upgrade

The reader support for online upgrade, software upgrades support the baseband software upgrade (the

underlying software) and application software upgrades (system software applications). Select "tools" on the main interface > "software upgrade" > "software", the pop-up dialog box, as shown in image 4-33:



Image 4-33 Application software upgrade

To find the Bin upgrade file path in the upgrade file drop-down list, click the upgrade progress bar shows 100% that means the application software upgrade successfully, pop-up upgrade prompted success dialog box, click OK to restart the reader, as shown in image 4-34.



Image 4-34 Software upgrade successfully

The process of the application of the base band software is the same as that of the application software.

5. Common failures

5.1 Daily maintenance

The routine maintenance of CL7206C usage:

- ☆To check whether the tightening of RF connector
- ☆To check if the screw fixed reader and antenna is loose
- ☆To check whether the RF cable joints appear outsourcing breaking the shielding layer
- ☆To check if the reader power line connection is reliable

5.2 Common failure analysis and solution

Power supply system failures:

Check whether the power adapter is normal, and the AC supply voltage is between 100V ~ 240V.

The panel indicator light failed when power on:

Check whether the communication is normal , please contact customer service if it's not normal.

The serial port unable to connect:

Check if the serial cable is not connected or connected unstable.

Check if the serial port connect baud rate of the reader is correct

Check if the selected COM port is right.

The network port cannot connect:

Factory set the default IP address: 192.168.1.116 when CL7206C reader device ex-factory, ensure the IP address of the PC and reader in the same network segment, such as "192.168.1.XXX" then you can connect to the reader, if you forget the IP address of the device, you can reset the reader's IP address through the serial port.

The reader can't read the tag

Check if the setting of antenna number is correct

Check if the label is damaged

Check if the label is placed in the reader's valid reading and writing range.

Check if the electromagnetic interference between the reader and the other device.

For the problem users cannot solve, please contact customer service.

6. Packing accessories, transportation and storage

6.1 Package

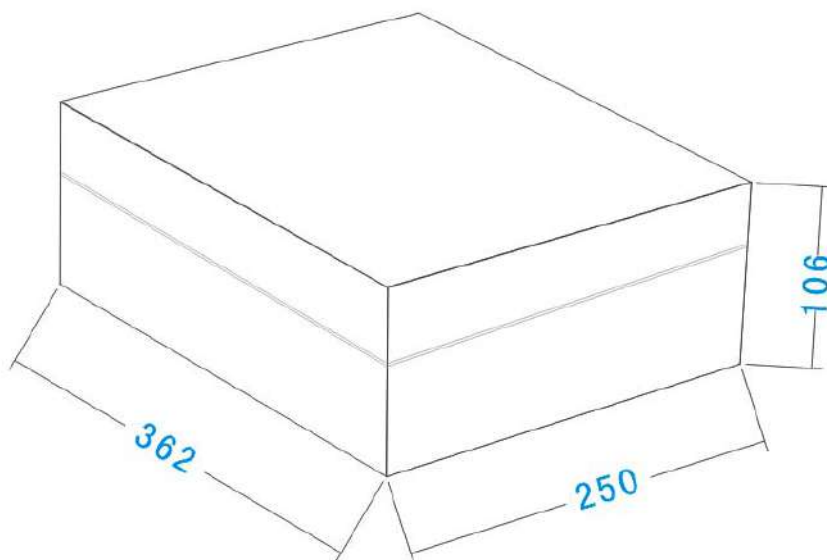

Imag6-1 Carton box size

Carton box size: 362 mm×250 mm×106mm

6.2 Accessories

In order to facilitate the storage and transportation in near future, the packing box and the packing material should be kept properly after unpack.

Besides of the device in the box, accessories equipped with the reader are also included in, please check the product packing list to confirm whether the product and accessories are complete, if any discrepancies or damage, please contact with the after-sale service in time.

The specific list of accessories as shown in table 6-1

Table 6-1 Package list

NO.	Name	Material Code	Qty	Unit	Remark
1	CL7206C four-port fixed reader	—————	1	set	Included
2	Power adapter 24V/2.5A	20109000000324	1	pcs	Included
3	AC power cord	20350000000195	1	unit	Included
4	Network cable	20350000000188	1	unit	Included
5	RS232 blackcable	20351000000478	1	pcs	Included
6	USB cable	20351000000036	1	pcs	Included
7	9dBi circularly polarized antenna	20351000000035	4	pcs	Included
8	Feeder line SMA-K--TNC-J 50ohm 3m	20351000000038	4	pcs	Included
9	Mounting screws M4*28	W01-104028-100	4	pcs	Included
10	Warranty card	20420000001651	1	pcs	Included
11	Certificate of approval	20420000001650	1	pcs	Included
12	CD	N10-010000-002	1	pcs	Included

6.3 Storage environment

CL7206C fixed reader should be stored in below conditions:

☆ Environment temperature : -40°C ~ +85°C

☆ Relative humidity : 5% RH ~ 95%RH

7. After-sale service

Letter to Customers

Since our aim is to continuously improve our products for better user experience, we may modify the product characteristics, composition and design of circuits without given notifications. Thus the real product may be not in accordance with this manual. Generally, we will provide timely amendments to this manual. If it's not provided timely, please consult our service department.

Shenzhen Clou Electrical Technology Co., Ltd.

Tel of Sales Dept: 0755-36901166-3302

Fax: 0755-26719679

Tel of Customer Service Dept: 0755-36901057

Fax: 0755-26719679

Guarantee card of Shenzhen Electrical Technology Co.,Ltd

Product Name		Model No.	
Product Code		Level	
Description of troubles			
User's name		Postcode	
Contact person		Contact no.	

Address of factory: Block 3 of CLOU Electronics Industrial Park, Baolong Industrial City, Longgang District ,Shenzhen, Guangdong, China (Interchange of Baolong road and Qingfeng Road)

Post code: 518057

Customer service centre: 8009990986

Warranty Description: In order to offer users better service, our company provide warranty card with each device, please keep it to enjoy the service.

1, Products can replace free under conditions within one month after sale, in the precondition of normal operation without repairing.

2, Free maintenance won't be given under the following circumstance:

- ① The damage of the terminal caused by high voltage of the power grid.
- ② The damage caused by misuse or operated improperly.
- ③ The damage caused by excessive vibration when user delivering.

3, The software of this product can be upgraded freely, users can be training in our company for free.

4, Will be charge appropriately if the user don't have a warranty card.

5, Users will need to fill out the warranty card for repair service, and sent back to CLOU.